

Experimental Investigation of Modified Direct Evaporative Cooler Using Heat Pipe

by Bambang Ariantara -

Submission date: 22-May-2023 02:56PM (UTC+0700)

Submission ID: 2099044966

File name: Experimental_Investigation_of_Modified_Direct_Evaporative.pdf (894.74K)

Word count: 3440

Character count: 18247

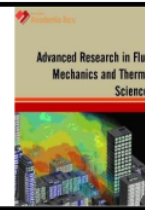

Experimental Investigation of Modified Direct Evaporative Cooler Using Heat Pipe

Open
Access

Bintang Fikri¹, Nandy Putra^{1,*}, Adi Winarta¹, Nasruddin A. Abdullah¹, Bambang Ariantara¹

¹ Heat Transfer Laboratory, Department of Mechanical Engineering Universitas Indonesia, Kampus UI, Depok 1642, Indonesia

ARTICLE INFO

Article history:

Received 28 September 2018

Received in revised form 29 October 2018

Accepted 4 December 2018

Available online 18 March 2019

ABSTRACT

Nowadays, keeping environment at comfort zone with conventional cooler become expensive, especially in wide and semi outdoor spaces. Evaporative cooler which offer a healthy, non-harmful materials, and low cost can be an alternative to keep environment healthy and comfortable. The objective of this experiment is to determine and compare the performance of direct evaporative cooler embedded with heat pipes and without heat pipes. Heat pipes are placed in the section before cooling pad and work as indirect stage. Evaporator sections of heat pipe are placed before cooling pad and the condenser section are placed in the addition sump. The results show that the saturation efficiency of both system increase along with the increase in inlet temperature and decrease along with the decrease in relative humidity. The saturation efficiency also decreases along with the increase in air velocity. The results also show that the saturation efficiency of modified evaporative cooler using heat pipe is higher than direct evaporative cooler. The addition of heat pipes can increase the saturation efficiency of direct evaporative cooler up to 1.03 without addition more power consumption.

Keywords:

Evaporative cooler, Energy efficiency,
Heat and mass transfer, Heat pipe

Copyright © 2019 PENERBIT AKADEMIA BARU - All rights reserved

1. Introduction

Providing air at comfort zone to wide and semi-outdoor space always need consideration. To control air at comfort zone in wide and semi-outdoor space using air conditioner with high cooling capacity will increased the energy consumption. Energy consumption in a building, approximately reach 40 to 50% energy demand [1]. This high energy consumption means higher cost is spent for air conditioning. As the cost is higher, lots of wide and semi-outdoor space do not have air conditioning system. They depend on ventilating system to provide indoor comfort air. Besides that, the human ability to adapt in higher thermal condition become another reason not to use air conditioner in this space. However, thermal condition can influence the performance of our activities. That's why, controlling air of wide and semi-outdoor space at comfort zone still necessary, especially in the room with high occupancy. Industrial building such as factory with large number of employee also need air

* Corresponding author.

E-mail address: nandyputra@eng.ui.ac.id (Nandy Putra)

conditioner to control air at comfort zone. De angelis *et al.*, [2] have studied the comfort zone of employee. They found that the comfort zone varied among the human, depend on the metabolism. They found the range of comfort zone is around 23-33°C. Lipczynska *et al.*, [3] also conducted a research about comfort zone and found that the performance of employees are higher at room temperature of 26°C.

Evaporative cooler is not new cooling device, it has been used over millennia. The working principle of evaporative cooler is it lower air temperature through water evaporation process. Evaporative cooler are classified as direct evaporative cooler, indirect evaporative cooler, two stage evaporative cooler, M-cycle, and dew-point indirect evaporative cooler [4]. In direct evaporative cooler, air flow through wetted cooling pad, the heat of air is used to evaporate water in cooling pad. The latent heat of evaporation causes the decreasing of air temperature and increasing of humidity of air. With that characteristic, direct evaporative cooler is well occupied in dry and humid climate, in the wide space, and in semi-outdoor building. Many researchers have already studied evaporative cooler. Bishoyi and Sudhakar [5] have conducted experimental to evaluate performance of direct evaporative cooler in composite climate of India. They varied the cooling pad type, comparing Honeycomb cooling pad and Aspen cooling pad. The result shows the energy efficiency and cooling capacity of Honeycomb cooling pad is better than Aspen cooling pad. Alkalibi [4] have studied the internal two-stage evaporative cooler by experimentally comparing the performance of direct evaporative cooler with the internal two-stage evaporative cooler. This study also comparing theoretically the performance of internal two-stage evaporative cooler with direct and external two-stage evaporative cooler. Al-Juwayhel *et al.*, [6] also conducted an experiment to investigate the performance of two-stage evaporative cooler. Boukhanouf *et al.*, [7] conducted an experiment and investigate the performance of heat pipe based indirect porous ceramic evaporative cooler. Heat pipe placed across the wet and dry channel of evaporative cooler as heat exchanger device. The result of their experiment showed that the addition of heat pipe as heat exchanger device give benefit in term of heat transfer effectiveness to the system. The temperature of product air in the dry channel decrease up to 5 °C.

Heat pipe are heat transfer devices with high heat transfer capacity. Heat pipe have compact size and do not require external power supply[8, 9]. Heat pipes have wide application and widely used in thermal management device. Heat pipe also used in heating, ventilation, and air conditioning system (HVAC). In HVAC system, heat pipe usually being used as heat transfer device for heat recovery. Saud Ghani *et al.*, [10] have conducted an experimental investigation about the usage of double heat pipe heat exchangers in air conditioning application. They have investigated the usage of double heat pipe condenser and evaporator in an air conditioning system serving 45 m³ balanced calorimeter of 2.24 kW heat load. The result shows that double heat pipe can reduce the compressor work and increase the system coefficient of performance (COP). Haitao Wang *et al.*, [11] have studied the efficiency of secondary heat recovery of heat pipe heat exchanger. They compared the energy consumption of secondary heat recovery HPHE AC system and the common heat recovery HPHE AC system. They found that secondary heat recovery HPHE AC system has an energy saving advantage.

As stated before, evaporative cooler can be configured as hybrid system, direct and indirect evaporative cooler combined in one system [12]. Besides that, combination direct evaporative cooler and indirect heat exchanger also studied by several researchers. Jain [13], Azhar [14] conducted an experiment and studied the saturation efficiency of two stages evaporative cooler. Heidarinejad [15] also studied the cooling performance of two stage evaporative cooler and found the efficiency varied in a range 108-111%.

The usage of heat pipe in the evaporative cooler is still in consideration. In this study, heat pipes are used as indirect stage of two stage direct evaporative cooler. The objective of this study is to

investigate experimentally the performance of direct-indirect two stages evaporative cooler using heat pipe as indirect stage.

2. Methodology

2.1 Modified Evaporative Cooler

The direct evaporative cooler was modified in this experiment. A row of heat pipes is embedded in the duct section before the cooling pad. This modification was purposed to make the system work double processes, remove sensible heat from air and change sensible heat into latent heat as water moisture. Heat pipes are used as the heat transfer element in this experiment. The heat pipe used in this experiment was made of cooper with a length of 700 mm and 10 mm in outer diameter. Water is used as heat pipes working fluid with 50% filling ratio. The heat pipe is divided into three parts, evaporator with a length of 300 mm, adiabatic with a length of 150 mm, and condenser with a length of 250 mm. Twenty five of heat pipes are arranged in a row. The heat pipe module configuration can be seen in Figure 1. The condenser part is submerged in addition sump with a dimension of 680 x 230 x 420 mm (see Figure 2.). The evaporation part is installed in inlet duct which has cross section dimension of 635 x 300 mm and length of 1000 mm.

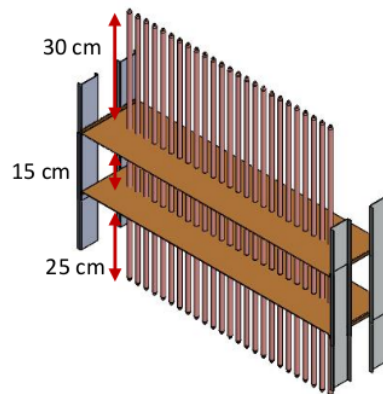

Fig. 1. Heat pipes dimension and configuration

The second part of this experiment is commercial direct evaporative cooler. The evaporative cooler used in this experiment is Aolan AZL06-ZC13B. In the back face area, evaporative cooling pad with dimension of 635 x 670 x 100 mm is mounted. In the front face area, diffuser with dimension of 490 x 400 mm is mounted. The evaporative air cooler used 1-phase axial fan to draw air through cooling pad and circulate air to cooled space. The schematic of modified direct evaporative cooler using heat pipe can be seen in Figure 2.

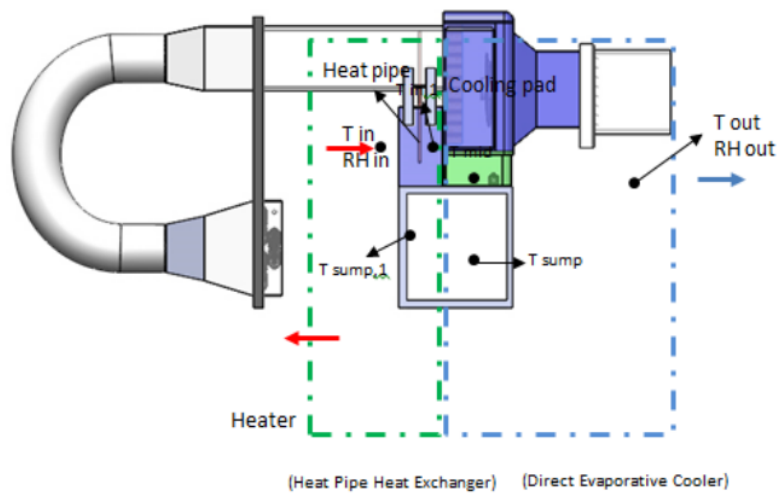

Fig. 2. Schematic of modified direct evaporative cooler

2.2 Experimental Setup

The experiment begins by turning on the direct evaporative cooler. The fan speeds are adjusted to two variations, low speed and high speed. Outdoor air is simulated by draw air through heater in the inlet duct. The heat generated by heater is adjusted using a PID controller. The inlet temperature variations used in this test were varied from 36 to 45°C with increment of 3°C. The air velocity variation used in this test were 0.8 m/s and 1.43 m/s. Water from the sump of evaporative air cooler is circulated through water hoses to the top part of evaporative cooler using submersible pump. Six K-type thermocouples are used to measure air temperature in the inlet duct (T_{in}), space between heat pipe and cooling pad ($T_{in,1}$), between cooling pad and fan (T_{mid}), in the outlet duct (T_{out}), in the water sump (T_{Sump}) and in the addition sump ($T_{Sump,1}$). Two humidity sensor are used in this experiment. The humidity sensor used in this experiment are Autonics humidity sensor type THD-DD1-V. A National Instrument Data Acquisition Module was used to assist the temperature and humidity measurement. The direct evaporative cooler without heat pipe experiment is conducted with the same experiment setup except the absence of heat pipe and one thermocouple between heat pipe and cooling pad. Figure 3 shows the experiment setup for modified direct evaporative cooler with heat pipes.

The process that occurred in the modified direct evaporative cooler began by hot air drawn through evaporator section of the heat pipes. The condenser section of heat pipes was submerged in the addition sump water to dispose heat from air. After the first process, the air was flown to the cooling pad section. The air velocity was varied by adjusting the fan speed. Low fan speed delivered 0.8 m/s air and high fan speed delivered 1.43 m/s air. The experiment was carried out for four hours each arrangement.

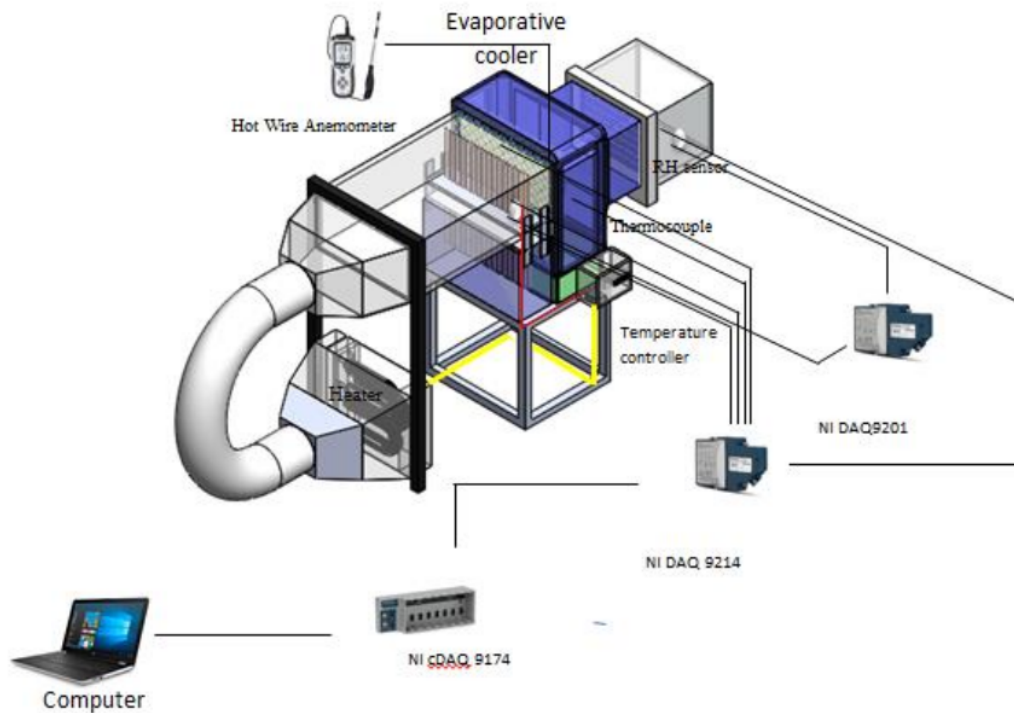

Fig. 3. Schematic of experimental setup

3. Results

3.1 Temperature Profile

Figure 4 shows the temperature profiles at measured position of direct evaporative cooler without heat pipe (DEC) and modified direct evaporative cooler with heat pipe (HP DEC). The graphs obtained from experiment in which the fan speed was set at low and high speed and the air inlet temperature was varied from 32°C to 36°C. From the Figure 4 (b) and (d), can be seen that $T_{in,1}$ has lower temperature than the inlet air temperature T_{in} . This decreasing temperature is the result of sensible heat being absorbed by the heat pipes. The decreasing temperature varied depend on inlet air temperature. The higher the inlet temperature, the greater the decreasing temperature. From the experiment, the decreasing temperature value by heat pipe are 0.32, 0.45, 0.58, and 0.69 °C for low fan speed (0.8 m/s air velocity) and 0.27, 0.41, 0.54, and 0.60 °C for higher speed (1.43 m/s air velocity). From this result, can be seen that the heat pipe reduces small amount of heat in the first stage.

Figure 5 shows the temperature difference of inlet temperature and air temperature after leaving cooling pad between two systems, direct evaporative cooler and modified direct evaporative cooler with heat pipes. It can be seen that the temperature difference is greater at higher temperature for both systems. This is the result of air characteristic in which hot and dry air is easier to contain moisture. At hot and dry air, more water evaporates to the air which cause more heat from the air being used to change water into moisture. From the figure, also can be seen that the temperature decrease of modified evaporative cooler is greater than direct evaporative cooler at low and high fan speed (0.8 m/s and 1.43 m/s air velocity). This results show that the modified evaporative cooler

removes more heat than direct evaporative cooler. The decreasing temperature of both systems are greater at low fan speed (0.8 m/s air velocity). This results show that the system is also affected by air velocity through the system.

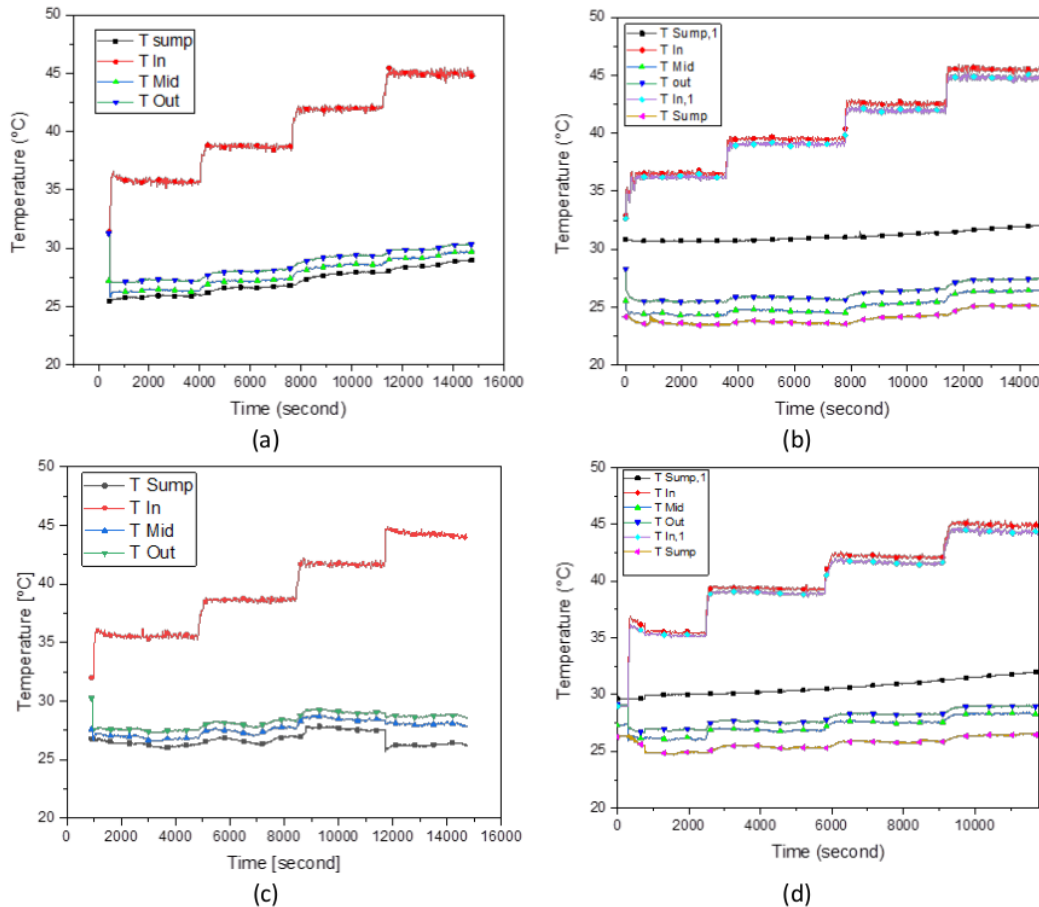

Fig. 4. Temperature profile at (a) low fan speed DEC (0.8 m/s air velocity), (b) low fan speed HP DEC (0.8 m/s air velocity), (c) high fan speed DEC (1.43 m/s air velocity), (d) high fan speed HP DEC (1.43 m/s air velocity)

3.2 The Effect of Inlet Temperature to Saturation Efficiency

The performance of modified direct evaporative cooler using heat pipe can be investigated by comparing the saturation efficiency of both systems. The saturation efficiency is the ratio of inlet-outlet temperature difference and wet bulb depression. Figure 6 shows the saturation efficiency of direct evaporative cooler and modified direct evaporative cooler with heat pipes. From the figure can be seen that fan speed affects the efficiency both of the system. Operating the system at low fan speed (0.8 m/s air velocity) lengthen the contact between air and water which cause the efficiency at low fan speed greater than at high fan speed (1.43 m/s air velocity). This results similar with the result obtained by other researchers [1]. The saturation efficiency of combination of heat pipe and direct evaporative cooler can exceed 100% at higher temperature. This results show that heat pipe can increase the performance of direct evaporative cooler. From the figure, also can be seen that the

efficiency between two system have a great difference. This difference not only caused by heat pipe effect but also caused by relative humidity difference. The smaller relative humidity value, the more water vapour can be contain in the air. This mean more heat being used to change water into vapour.

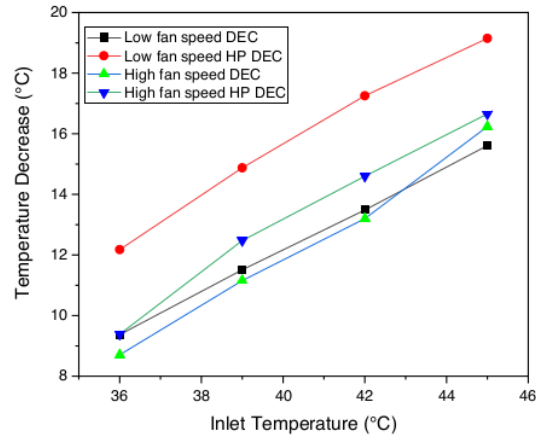

Fig. 5. Inlet and leaving cooling pad temperature difference of Direct Evaporative Cooler (DEC) and Modified Direct Evaporative Cooler with Heat Pipe (HP DEC)

The saturation efficiency of both systems also affected by inlet temperature. The saturation efficiency increases along with increasing temperature. From the Figure 7, the increase of temperature causes decreases in relative humidity (RH) and increase wet bulb temperature. As the wet bulb temperature increase, the maximum heat can be removed from air also increase. The result is the saturation efficiency of direct evaporative cooler increase. From the figure, also can be seen that the saturation efficiency of modified direct evaporative cooler with heat pipes are higher than direct evaporative cooler, this is in accordance with the theory.

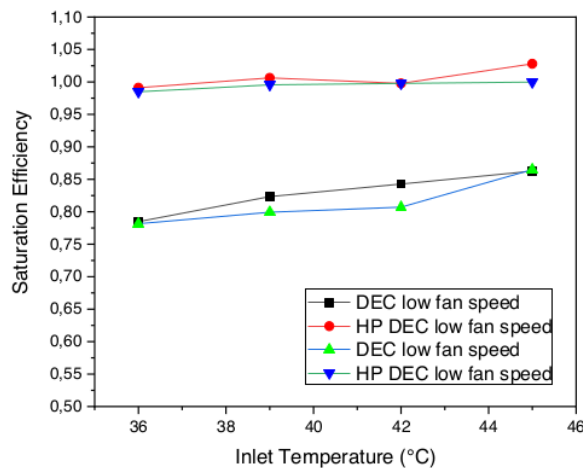

Fig. 6. Saturation efficiency of Direct Evaporative Cooler (DEC) and Modified Direct Evaporative Cooler with Heat Pipe (HP DEC)

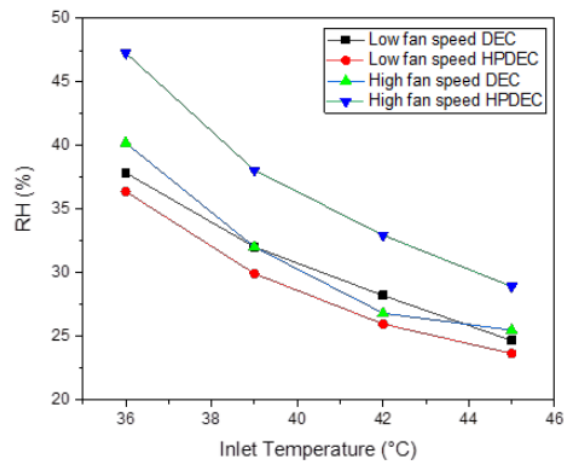

Fig. 7. Inlet air relative humidity of direct evaporative cooler and modified direct evaporative cooler with heat pipe

4. Conclusions

This experimental data and analysis give explanation about the effect of inlet air parameter such as temperature, humidity, and air flow to the performance of direct evaporative cooler and modified direct evaporative cooler with heat pipe. According to this research, the saturation efficiency of both system increase along with inlet temperature increase but decrease as the relative humidity and air velocity increase. The greatest saturation efficiency of the system obtained when the direct evaporative cooler combined with heat pipe. The greatest saturation efficiency value is 1.03. The greatest reduced Dry bulb temperature from the inlet to outlet is 18.15 °C which obtained when the system is operated at low fan speed (0.8 m/s air velocity) and highest inlet temperature (45 °C). Temperature difference between inlet air and point after air leaving cooling pad have a biggest value (19.15 °C) when operated at low fan speed (0.8 m/s air velocity), highest inlet temperature, smallest relative humidity, and combined with heat pipe. Considering the design of the heat pipe and the result in this experiment, it still has plenty chance to improve the heat pipe design for direct evaporative cooler.

Acknowledgement

The authors wanted to express gratitude to DRPM Universitas Indonesia and Kemenristek Dikti for funding this research through "Hibah PPUPT" scheme.

References

- [1] Sivak, Michael. "Potential energy demand for cooling in the 50 largest metropolitan areas of the world: Implications for developing countries." *Energy Policy* 37, no. 4 (2009): 1382-1384.
- [2] De Angelis, Alessandra, Onorio Saro, and Massimo Truant. "Evaporative cooling systems to improve internal comfort in industrial buildings." *Energy Procedia* 126 (2017): 313-320.
- [3] Lipczynska, Aleksandra, Stefano Schiavon, and Lindsay T. Graham. "Thermal comfort and self-reported productivity in an office with ceiling fans in the tropics." *Building and Environment* 135 (2018): 202-212.
- [4] Alklaibi, A. M. "Experimental and theoretical investigation of internal two-stage evaporative cooler." *Energy Conversion and Management* 95 (2015): 140-148.

- [5] Bishoyi, Deepak, and K. Sudhakar. "Experimental performance of a direct evaporative cooler in composite climate of India." *Energy and Buildings* 153 (2017): 190-200.
- [6] Al-Juwayhel, Faisal I., Amir A. Al-Haddad, Habib I. Shaban, and Hisham TA El-Dessouky. "Experimental investigation of the performance of two-stage evaporative coolers." *Heat Transfer Engineering* 18, no. 2 (1997): 21-33.
- [7] Boukhanouf, R., A. Alharbi, O. Amer, and H. G. Ibrahim. "Experimental and numerical study of a heat pipe based indirect porous ceramic evaporative cooler." *International Journal of Environmental Science and Development* 6, no. 2 (2015): 104.
- [8] Putra, Nandy, and Bambang Ariantara. "Electric motor thermal management system using L-shaped flat heat pipes." *Applied Thermal Engineering* 126 (2017): 1156-1163.
- [9] Chaudhry, Hassam Nasarullah, Ben Richard Hughes, and Saud Abdul Ghani. "A review of heat pipe systems for heat recovery and renewable energy applications." *Renewable and Sustainable Energy Reviews* 16, no. 4 (2012): 2249-2259.
- [10] Ghani, Saud, Seifelislam Mahmoud Ahmad Gamaledin, Mohammed Mohammed Rashwan, and Muataz Ali Atieh. "Experimental investigation of double-pipe heat exchangers in air conditioning applications." *Energy and Buildings* 158 (2018): 801-811.
- [11] Wang, Haitao, Shunbao Zhou, Zhongshi Wei, and Ren Wang. "A study of secondary heat recovery efficiency of a heat pipe heat exchanger air conditioning system." *Energy and Buildings* 133 (2016): 206-216.
- [12] Duan, Zhiyin, Changhong Zhan, Xingxing Zhang, Mahmud Mustafa, Xudong Zhao, Behrang Alimohammadisagvand, and Ala Hasan. "Indirect evaporative cooling: Past, present and future potentials." *Renewable and Sustainable Energy Reviews* 16, no. 9 (2012): 6823-6850.
- [13] Jain, Dilip. "Development and testing of two-stage evaporative cooler." *Building and Environment* 42, no. 7 (2007): 2549-2554.
- [14] Azhar, K. M. "Experimental Performance of Two-stage Evaporating Cooling System." *Scholars Journal of Engineering and Technology* (2013).
- [15] Heidarinejad, Ghassem, Mojtaba Bozorgmehr, Shahram Delfani, and Jafar Esmaeelian. "Experimental investigation of two-stage indirect/direct evaporative cooling system in various climatic conditions." *Building and Environment* 44, no. 10 (2009): 2073-2079.

Experimental Investigation of Modified Direct Evaporative Cooler Using Heat Pipe

ORIGINALITY REPORT

19%

SIMILARITY INDEX

13%

INTERNET SOURCES

15%

PUBLICATIONS

5%

STUDENT PAPERS

MATCH ALL SOURCES (ONLY SELECTED SOURCE PRINTED)

3%

★ Hery Sonawan, Evi Sofia, Arief Ramadhan.

"Assessment of direct evaporative cooler performance with a cooling pad made from banana midrib and ramie fiber", Smart and Sustainable Built Environment, 2020

Publication

Exclude quotes On

Exclude matches < 1%

Exclude bibliography On